

RCA

USER'S GUIDE

colortelevisioncolortelevisionco
lortelevisioncolortelevisioncolo
rtelevisioncolortelevisioncolort
elevisioncolortelevisioncolortel
evisioncolortelevisioncolortele
visioncolortelevisioncolortelevisi
oncolortelevisioncolortelevision
colortelevisioncolortelevisionco
lortelevisioncolortelevisioncolo
rtelevisioncolortelevisioncolort
elevisioncolortelevisioncolortel
evisioncolortelevisioncolortele
visioncolortelevisioncolortelevisi
oncolortelevisioncolortelevision
colortelevisioncolortelevisionco
lortelevisioncolortelevisioncolo
rtelevisio televisioncolort
elevisioncolort televisioncolortel
evisioncolort televisioncolortele
visioncolort televisioncolortelevisi
oncolort televisioncolortelevision
colortelevisio televisioncolort
lortelevisio televisioncolort
rtelevisio televisioncolort
elevisioncolort televisioncolortel
evisioncolort televisioncolortele
visioncolort televisioncolortelevisi
oncolort televisioncolortelevision
colortelevisio televisioncolort
lortelevisio televisioncolort
rtelevisio televisioncolort
elevisioncolort televisioncolortel
evisioncolort televisioncolortele



IMPORTANT INFORMATION

WARNING

To reduce the risk of fire or electric shock, do not expose this TV to rain or moisture.

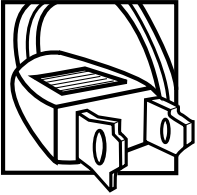

Caution: To prevent electric shock, match wide blade of plug to wide slot, fully insert.

Attention: Pour éviter les chocs électriques, introduire la lame la plus large de la fiche dans la borne correspondante de la prise et pousser jusqu'au fond.

Refer to the identification/rating label located on the back panel of your product for its proper operating voltage.

FCC Regulations state that unauthorized changes or modifications to this equipment may void the user's authority to operate it.

If fixed (non-moving) images are left on the screen for long periods, they may be permanently imprinted on the screen. Such images include network logos, phone numbers, and video games. This damage is not covered by your warranty. Extended viewing of channels displaying these images should be avoided.

Cable TV Installer: This reminder is provided to call your attention to Article 820-40 of the National Electrical Code (Section 54 of the Canadian Electrical Code, Part 1) which provides guidelines for proper grounding and, in particular, specifies that the cable ground shall be connected to the grounding system of the building as close to the point of cable entry as practical.

WARNING

RISK OF ELECTRIC SHOCK. DO NOT OPEN

To reduce the risk of electric shock, do not remove cover (or back). No user serviceable parts inside. Refer servicing to qualified service personnel.



This symbol indicates "dangerous voltage" inside the product that presents a risk of electric shock or personal injury.



This symbol indicates important instructions accompanying the product.

TABLE OF CONTENTS

GETTING STARTED	1	V-Chip Movie Rating Limit	6
Setup and Connection	1	Blocking Movie Ratings	6
Dipole Antenna Connection	1	Viewing Movie Ratings	6
Channel Marker	2	V-Chip TV Rating Limit	6
Front Panel Controls	2	The TV Rating Limit Screen	7
Tour of the Remote	3	Blocking Age-Based Ratings and Content Themes	8
THE MENU SYSTEM	4	Viewing Age-Based Ratings and Content Themes	8
TV Main Menu	4	V-Chip Unrated Program Block	9
The Picture Quality Menu	4	Lock/Unlock Parental Controls	9
The Screen Menu	4	The Time menu	9
The Channel Menu	5	TROUBLESHOOTING	10
V-Chip and Parental Controls	5	ACCESSORIES	11-12
		LIMITED WARRANTY	13

GETTING STARTED

SETUP AND CONNECTION

Step 1: Connect Your TV

Connect the cable from your cable system or off-air antenna to the cable in-jack on the back of the TV, as shown.

ANTENNA, CABLE, CABLE BOX OR VCR

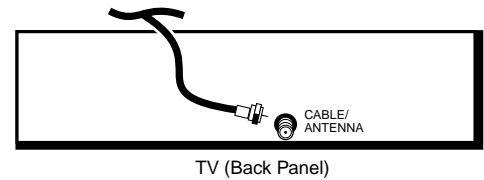

Step 2: Plug In Your TV

Plug the end of the power cord into the wall outlet, matching the wide blade of the plug with the wide slot in the outlet. Be sure to insert the plug completely.

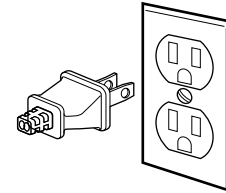

Step 3: Put Batteries in the Remote Control

1. Remove the battery compartment cover from the back of the remote.
2. Insert batteries as shown, matching the + and – ends of each battery in the compartment.
3. Replace the cover.

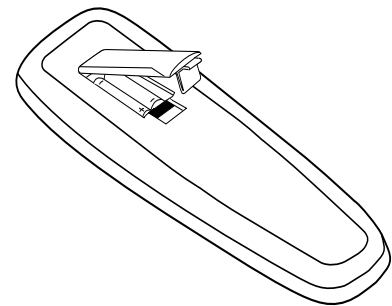

Step 4: Turn on the TV

Press the POWER button on the remote or front panel.

Step 5: Auto Channel Search

Perform an *Auto Channel Search* (described in the *Channel* menu section).

DIPOLE ANTENNA CONNECTION

Follow the steps to connect the indoor antenna supplied with your TV (only if you do not connect an outdoor antenna or a cable-TV system).

Insert the antenna base into the pocketed slot on the back of your set. Stand at the back of your set with the antenna twin-lead facing you, and press the base of the antenna into the slot until it locks in place.

Connect the ends of the twin-lead to the Antenna Adapter (supplied).

Connect the Antenna Adapter to the ANTENNA connector on the back of the TV.

Later, after you've turned on the TV, adjust the length and position of the antenna rods for best reception.

- For viewing VHF channels, extend the rods fully.
- For viewing UHF channels, shorten the rods for best reception.

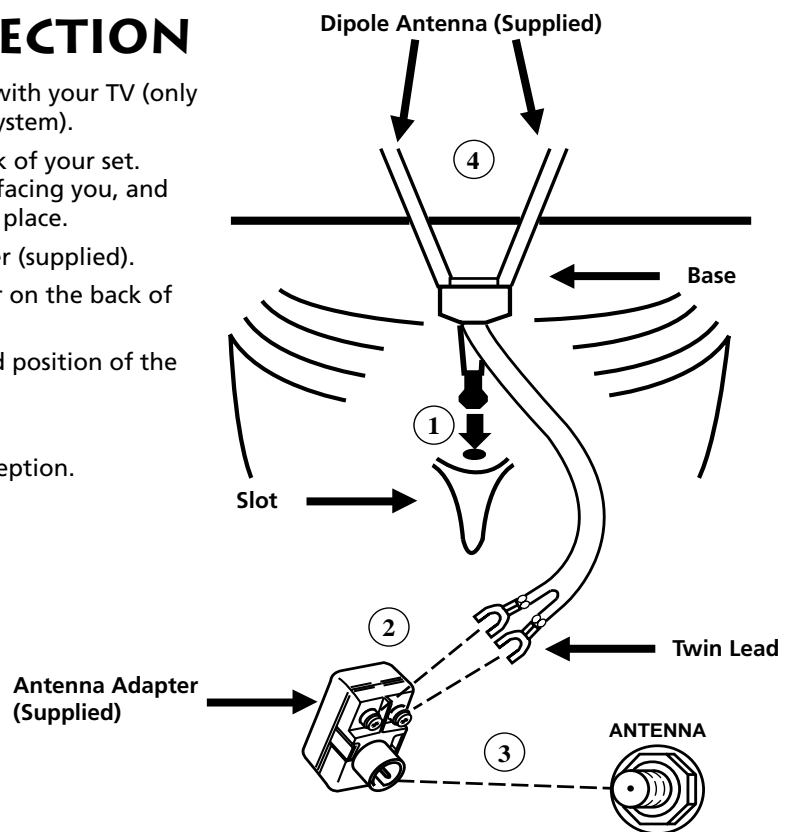

GETTING STARTED

CHANNEL MARKER

The Channel Marker comes up when you first turn on the TV, change channels, or press the DISPLAY button.

01:30 Displayed to count down time left on the commercial skip timer.

13 Displays the current channel.

7:17 Displays the current time.

CC Displayed when Closed Captioning is available.

Mute Displayed when you mute the audio.

Sleep Displayed when the Sleep Timer has been set.

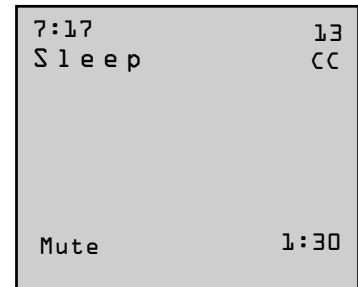

The Channel Marker shown is just an example of what your screen may look like.

FRONT PANEL CONTROLS

CHAN ^ Scans up through the channel list. When a menu is displayed, CHAN^ points up to items and adjusts menu controls.

CHAN v Scans down through the channel list. When a menu is displayed, CHANv points down to items and adjusts menu controls.

MENU Brings up the Main menu. When in the menu system, it selects highlighted items. Also returns you to the previous menu.

POWER Turns the TV on and off.

VOL - Decreases the volume. When in the menu system, VOL - is used to point left to items and adjust menu controls.

VOL + Increases the volume. When in the menu system, VOL + is used to point right to items and adjust menu controls.

You can press MENU or CLEAR to make the Channel Marker disappear, or it will disappear automatically after a short time.

FRONT PANEL JACKS

Audio IN and Video IN Jacks

Receives audio signals from another component, like a VCR or camcorder when it is connected to these jacks. You may have to purchase audio and video cables from your local electronics store.

To select these front panel jacks, press INPUT on your remote control.

FRONT PANEL LOCK

This feature allows you to lock the buttons on the front of the TV. Even when the front panel lock feature is ON, the TV operates with the remote control.

- To lock the buttons on the front of the TV, make sure the TV is turned ON, then press and hold the POWER button on the remote for approximately 5 seconds.
- To turn off the front panel lock, make sure the TV is OFF, then press and hold the POWER button on the remote for approximately 5 seconds. Now the buttons will operate properly.

Caution

If you choose to use a stand with your TV, take precautions that the stand or other furniture the TV is placed on is properly located and of adequate size and strength to prevent the TV from accidentally being pushed off, pulled off, or tipped over. This could cause damage to the TV and/or personal injury.

GETTING STARTED

REMOTE CONTROL BUTTONS

When operating the remote, point it directly at the front of the TV. Objects between the remote and the remote sensor can block the signal to the TV.

POWER Button Press to turn the TV on or off.

PREV CH Button (Previous Channel) Pressing this button switches the TV back to the last tuned channel. This is useful if you want to watch two channels. Select the first channel you wish to watch. Then select the other channel by pressing two number buttons. The TV changes back and forth between the two channels each time you press this button.

DISPLAY Button Press to display the time and channel number on the screen. Press to see if the Sleep Timer, Alarm Timer, and Closed Captioning are set. Press to quickly remove menus from the screen unless otherwise noted within the menu.

MUTE Button Press to quickly reduce sound to minimum level. Closed captioning (C1) may appear on the screen when you press MUTE. To restore sound and normal picture, press MUTE again or press VOL up.

CHAN \wedge / \vee Buttons (Channel Up and Down) Press to select the next higher or lower channel in memory. You can add or erase channels in memory as desired. *Details are on page 5.*

VOL Buttons (Volume Up and Down) (Also – and + Buttons) Press VOL + to increase volume, or press VOL – to decrease volume. Press + or – to adjust the setting of an item that is highlighted in a menu. The volume display appears on the screen when you press the VOL buttons. When a menu is displayed, press + or – to adjust the setting of an item that is highlighted in a menu.

MENU Button Press to bring up the menu screen, then press the channel up and down buttons to choose desired menu choice, and then press the + or - to adjust each setting.

RESET Button Press to return all video settings (color, tint, contrast, brightness, and sharpness) back to the original settings.

CLEAR Button Press to clear the screen of all on-screen displays.

Number Buttons (0-9) Press to access any channel number. To select a channel, press two number buttons. For example, press 0 then 6 for channel 6. To select a 3-digit number, press and hold number button 1 until 1— appears on the screen. Then press the other two numbers.

INPUT Button Press to tune to the front Audio/Video input. Press again to return to the regular program material.

Note: Make sure source connected to input jacks is turned on.

SKIP Button (Commercial Skip) Starts an on-screen countdown timer. While the timer is on the screen, you can browse through other channels. Each press of the SKIP button adds 30 seconds to the timer. When the timer reaches 0:00, the TV will automatically go back to the channel it was on when the timer was started.

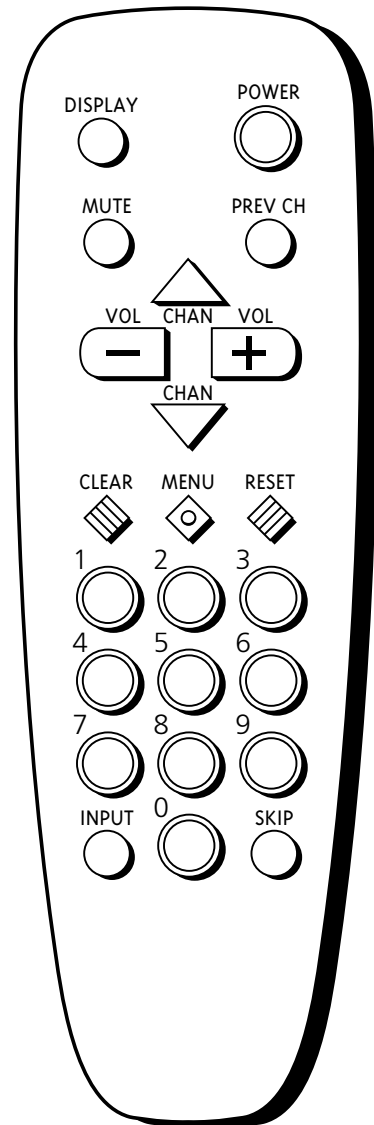

Point and Select

To use the on-screen menus, you need to know one rule: point and select:

- Point to your selection with the on-screen highlight. (Use the Vol+/- buttons on your remote to move left and right; use the CH \wedge / \vee buttons to move up and down.)
- Press the MENU button to select the highlighted item.

THE MENU SYSTEM

TV MAIN MENU

The *TV Main Menu* is your gateway to controlling the TV. It lets you adjust the TV's picture quality, screen, channel settings, parental controls, and time functions.

To select a menu item:

1. Press MENU to bring up the *TV Main Menu*.
2. Use the CHAN \wedge / \vee on the remote or front of TV to highlight an item and press MENU to select it; or you can also press the corresponding number on the remote.
3. To exit any menu screen, highlight *Exit* and press MENU, or press CLEAR on the remote.

THE PICTURE QUALITY MENU

The *Picture Quality Menu* contains five controls that adjust the TV's picture. Use the VOL +/- and CH +/- buttons to adjust the controls.

Contrast Adjusts the difference between light and dark areas of the picture.

Color Adjusts the richness of the color.

Tint Adjusts the balance between the red and green levels allowing you to get the correct fleshtones.

Black Level Adjusts the brightness of the picture.

Sharpness Adjusts the crispness of edges in the picture.

Reset Picture Controls Resets the picture controls to their original settings.

THE SCREEN MENU

The *Screen* menu contains the controls that let you adjust the Closed-Caption display, Closed-Caption mode, and Menu Language.

CC (Closed-Caption) Display Lets you choose the way closed captioning information is shown on the screen. Use the MENU button to toggle between the following:

Off No captioning information displayed.

On Captioning information shown always, when available.

On When Muted Displays captioning information, when available, whenever you press the MUTE button. The captioning information is not displayed when the sound is not muted.

CC (Closed-Caption) Mode Lets you choose which captioning mode is used for displaying captioning information. Use the MENU button to toggle between the choices: CC1 and CC2.

Not all programs are encoded with closed-captioning information. When a program is closed captioned, the letters CC are displayed under the Channel Marker.

Menu Language Lets you select the language of your choice: English, French, or Spanish. Use the MENU button to toggle between the choices.

TV Main Menu

- 1 Picture Quality
- 2 Screen
- 3 **Channel**
- 4 V-Chip Parental Controls
- 5 Time
- 0 Exit

The TV Main Menu

Picture Quality Menu

- 1 Contrast +.....|.....-
- 2 Color +.....|.....-
- 3 Tint +.....|.....-
- 4 Black Level +.....|.....-
- 5 Sharpness +.....|.....-
- 6 Reset Picture Controls
- 7 Exit

The Picture Quality Menu

Tip

You can also use the RESET button on the remote at any time to reset the picture controls to their original settings.

Screen

- 1 **CC Display:** OFF
- 2 CC Mode: CC1
- 3 Menu Language: English
- 0 Exit

The Screen menu

Closed Caption Modes

CC1: full translation of the primary language in your area

CC2: secondary language translation, simplified English, or whatever is being broadcast in your area

THE MENU SYSTEM

THE CHANNEL MENU

The *Channel* menu contains all the commands used to control your channels, including custom-building your channel list.

Signal Type Displays a toggle that lets you select the current antenna type:

Antenna Choose this if you are currently using an off-air antenna for UHF/VHF TV signals.

Cable TV Choose this if you are currently using cable or a cable box for TV signals.

Auto Channel Search Selecting this option tells the TV to search automatically for all the channels available through the antenna input. When the TV finds an active channel, it places it in the channel list. Inactive channels (weak stations or channels with no signal at all) will be removed from the channel list. (You may interrupt this process by pressing the MENU button.)

List Displays a control panel that lets you customize your channel scan list by adding or removing channels. Use the VOL +/- buttons to move left and right between fields; use the CH ^/v buttons to enter settings. Press MENU to exit.

Channel Number Use the CH ^/v buttons to scroll through the channel scan list. You can also enter the channel number directly using the number buttons.

Scan List Indicates whether the channel number is included (YES) or is not included (NO) in the channel scan list.

Channel	
1 Signal Type:	CABLE TV
2 Auto Channel Search	
3 List	
0 Exit	

The Channel menu

List	
Chan #	Scan List
059	YES
^	
v	
Press MENU to exit.	

List menu

V-CHIP PARENTAL CONTROLS

The *V-Chip Parental Controls* menu allows you to program your TV so that children cannot see certain programs. When you select *V-Chip Parental Controls*, you will be prompted to enter your password if controls are locked, or to remember to lock controls if unlocked.

The first three choices in the Parental Controls menu involve software inside your TV (dubbed V-Chip) which allows you to block TV programs and movies based on violence, sex, or other content you believe children should not view. Once you block programs, you or other adults can unblock programs with a password.

When turned "on," the software reads a code that most broadcasters send with programs. That code tells the V-Chip the program's age-based rating and content themes. If you have blocked the rating or content themes that the program contains, you will receive the message, "This program is blocked. Change channel or press DISPLAY to enter password." When you tune to that program.

Broadcasters are not required to provide content themes or age-based ratings. Rated programs received with no content themes will only be blocked if you block their age-based rating. You can also block movies with a rating of "Not Rated" and "unrated" TV programs.

TV Main Menu	
1 Picture Quality	
2 Screen	
3 Channel	
4 V-Chip Parental Controls	
5 Time	
0 Exit	

Setting V-Chip Parental Controls

The V-Chip software inside your TV comes turned "off," so if you choose to implement it, you must turn it on.

THE MENU SYSTEM

V-CHIP MOVIE RATING LIMIT

With the *Movie Rating Limit* you can set movie-viewing limits.

Blocking Movie Ratings

You can automatically block all movie ratings above a specified rating using *Movie Ratings Limit* in the Parental Controls menu.

- **To block all movies above a certain rating:** In the Rating field, use CH[^]/_v to highlight the *lowest unacceptable* rating. Then highlight the Rating Status field and press the CH[^]/_v buttons to change the status from *View* to *Block*. All higher ratings will automatically change to *Block*.
- **To lock your selection(s):** Select *Parental Controls* from the Parental Controls menu. Press the Vol + to select LOCKED. Enter your password (if you have not already set your password, you will be prompted to enter it again to confirm). The word UNLOCKED will flash to remind you that the Parental Controls are not LOCKED.

Viewing Movie Ratings

After you block movie ratings, you have the option of changing some of the ratings back to *View*.

- **To view movie ratings:** Highlight the Rating field and use the CH[^]/_v buttons to find the rating you want to view. Then use VOL+ to highlight the Rating Status field, and use CH[^]/_v to change the status to *View*.

V-CHIP TV RATING LIMIT

The V-Chip TV Rating Limit lets you decide which TV programs can be viewed. To set TV programming limits:

1. Choose *V-Chip Parental Controls* from the Main menu. If Parental Controls have previously been locked, you must enter your password. If they are not locked, you will get a message reminding you that your limits will not be effective until you lock Parental Controls.
2. Press MENU to continue.
3. Highlight and select *TV Rating Limit*.
4. Once you get to the TV Rating Limit screen, use the CHAN[^]/_v and VOL +/- on your remote to change the status of a TV program rating or content theme from *View* to *Block*.

The following sections give you more details about how to change the status of TV program limits.

V-Chip Parental Controls

- 1 **Movie Rating Limit**
- 2 TV Rating Limit
- 3 Unrated Programs: VIEW
- 4 Parental Controls: UNLOCKED
- 0 Exit

Selecting Movie Rating Limit

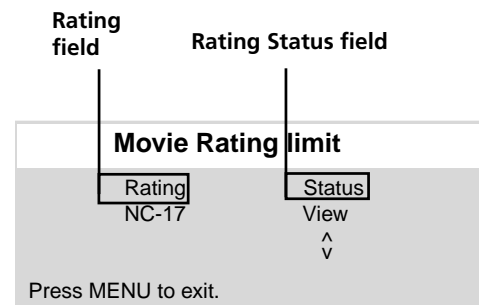

Viewing movie ratings

V-Chip Parental Controls

- 1 **Movie Rating Limit**
- 2 **TV Rating Limit**
- 3 Unrated Programs: VIEW
- 4 Parental Controls: UNLOCKED
- 0 Exit

Selecting TV Rating Limit

TIP

When you change the status of an age-based rating to **Block**, the system will automatically block that rating and all of its content themes and all higher ratings and their content themes. When you change the status of a Content Theme to **B**, the system will automatically block that content theme in the current rating and in all higher ratings. Only the content theme status corresponding to the current age-based rating changes to **View (V)**. Higher rated content themes do not change.

THE MENU SYSTEM

The TV Rating Limit Screen

Below is an example of where items are located within the TV Rating Limits screen.

Tip

You can always press MENU to exit back to the previous screen while in the Rating Limit menus.

Rating field

Lets you select from a list of age-based ratings you can block or view.

Pointer Highlight

Lets you see the position of the cursor on the screen.

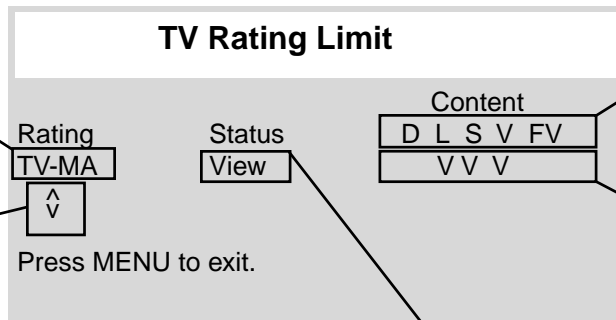

Content Themes

Lets the content themes you can block or view.

Content Status fields

Lets you select which content themes to view for the selected rating, and whether the status of the content theme is currently View (V) or Block (B).

Rating Status field

Lets you select whether the status of the age-based rating limit to the left is View or Block.

The TV age-based ratings and content themes you can block are listed in the table below.

Age-Based Rating	Description and Content Themes for Age-Based Ratings
TV-MA	Mature Audience Only. Specifically designed to be viewed by adults and may be unsuitable for children under 17. It contains one or more of the following content themes: graphic violence (V), explicit sexual activity (S), or crude indecent language (L).
TV-14	Parents Strongly Cautioned. Contains some material that many parents would find unsuitable for children under 14. Parents are strongly urged to exercise greater care in monitoring this program and are cautioned against letting children under the age of 14 watch unattended. This program contains one or more of the following content themes: intense violence (V), intense sexual situations (S), strong coarse language (L), or intensely suggestive dialogue (D).
TV-PG	Parental Guidance Suggested. Contains material that parents may find unsuitable for younger children. Many parents may want to watch it with their younger children. The program contains one or more of the following content themes: moderate violence (V), some sexual situations (S), infrequent coarse language (L), or some suggestive dialogue (D).
TV-G	General Audience. Most parents would find this program suitable for all ages. It contains little or no violence (V), sexual situations (S) no strong language, (L) and little or no sexual dialogue (D).
TV-Y7	Directed to Children 7 years and older. Designed for children ages 7 and above. It may be more appropriate for children who have acquired the developmental skills needed to distinguish between make-believe and reality. Themes and elements in this program may include mild fantasy violence (FV) or comedic violence, or may frighten children under the age of 7.
TV-Y	All Children. Themes and elements in this program are designed for a young audience, including children from ages 2-6. It is not expected to frighten younger children.

THE MENU SYSTEM

Blocking Age-Based Ratings and Content Themes

You can automatically block all program ratings or content above a specified age-based rating level using the V-Chip *TV Rating Limit* screen.

Refer to the chart at the beginning of this section to learn about each age-based rating and its associated content ratings.

- **To block all programs above a certain rating level:** Highlight the Rating field, then scroll through the ratings using the CH[^]/v buttons until the *lowest unacceptable* rating is highlighted. Then use the VOL + button to highlight the Rating Status field and select Block.
- **To block all programs with specific content above a certain rating level:** Content Themes are specific to the rating level. Therefore, you must first highlight the Rating field and scroll through the ratings using the CH[^]/v buttons until the *lowest* rating associated with the type of content you want to block is highlighted. Then highlight the Content Theme Status field and change the V to B under the appropriate Content Theme.

Viewing Age-Based Ratings and Content Themes

After you have blocked age-based ratings and content themes, you have the option of selectively changing some of the ratings and themes back to View.

- **To view ratings:** Use the VOL +/- buttons to highlight the Rating Field, then use CH[^]/v to change its status from Block to View. When you change a specific rating to View, the Content Status fields corresponding to the unblocked rating become View as well.
- **To view content:** Highlight the Rating field, then use CH[^]/v to find the rating whose Content Theme settings you want to change. Next, highlight the Content Theme Status that you want to change using the VOL + button; then use CH[^]/v to change it to V.

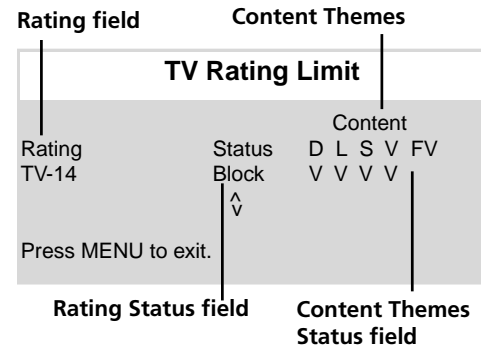

Blocking age-based ratings and content themes

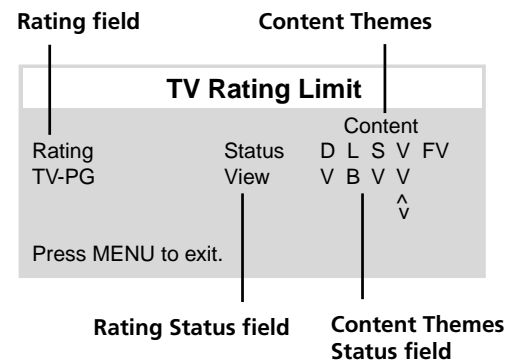

Viewing age-based ratings and content themes

While within the Rating Limit screens, pressing RESET on the remote will reset all ratings to View and V.

Overriding Limits
When you override a blocked program by entering your password, the Parental Controls option on the V-Chip Parental Controls menu will read *Disabled*. In this state, access to the Parental Controls menu is still locked and all controls will be in effect the next time the TV is turned on.

THE MENU SYSTEM

V-CHIP UNRATED PROGRAM BLOCK

Selecting this option lets you decide if programs that the V-Chip recognizes as “unrated” can be viewed.

View All unrated programs are available.

Block No unrated programs are available.

“Unrated” TV programs may include news, sports, political, religious, local, and weather programs, and public announcements. Also, the first few seconds of a channel with rated programming may be blocked (due to a brief delay in transmission of the rating information).

LOCK/UNLOCK PARENTAL CONTROLS

Selecting this option lets you lock and unlock parental controls settings using a password.

You must lock Parental Controls for TV rating and content, movie rating, and unrated program blocks to take effect.

If you forget your password, the password can be reset to 0000 by pressing and holding the volume down and the channel up buttons simultaneously for five seconds. Using this password, you can then access the V-chip menus.

THE TIME MENU

The *Time* menu contains the controls that let you set the *Sleep Timer*, *Set Time*, and *Wake-up Timer* functions.

Sleep Timer Displays a control panel that lets you select the amount of time you want to give the TV before it shuts itself off. Use the VOL+/- buttons to increase or decrease the sleep timer by 30minute increments. Press MENU to exit.

Set Time Displays a control panel that lets you enter the current time. Use the VOL+/- buttons and number buttons to set the time. Press MENU to exit.

Wake-up Timer Displays a control panel that lets you enter the time you wish your television to turn itself on. Use the VOL+/- buttons to set the wake-up timer. To clear the wake-up timer, display the wake-up screen and press RESET.

“Unrated” vs. “Not Rated”

All movies are assigned a rating. Some movies are given a rating of Not Rated (NR). You can assign Block or View status to the NR rating in the V-Chip Movie Rating Limit screen.

Not all television programs are assigned a rating (age-based rating). To assign View or Block status to “unrated” television programs, you must use the Unrated Programs option from the V-Chip Parental Controls menu.

Remember

When you want to watch a blocked program, press the DISPLAY button on the remote to enter your password.

Time	
1	Sleep Timer
2	Set Time
3	Wake-up Timer
0	Exit

The Time menu

TROUBLESHOOTING

If you experience any difficulty with your TV, check these basic remedies before calling your service technician.

TV will not turn on or controls don't work

- Check to make sure it is plugged in.
- Check the wall receptacle (or extension cord) to make sure it is "live" by plugging in something else.
- Try unplugging set for one minute, plugging it back in, and then turning it on again.
- Make sure the Front Panel Lock feature is not set.

Problems with remote

- Maybe something is between the remote and the remote sensor.
- Maybe the remote is not aimed directly at the TV's remote sensor.
- Maybe batteries in remote are weak, dead or installed incorrectly. Try replacing batteries.

Turns on or off while playing

- Electronic protection circuit may have been activated because of a power surge. Wait 30 seconds and then turn on again. If this happens frequently, the voltage in your house may be abnormally high.
- Maybe the Sleep Timer or Alarm Timer is activated.

Blank screen or black box appears on the screen

- Try another channel.
- Press RESET, in case the picture controls are set too low.
- Captioning may be turned on. Check the Closed-Caption Display control panel in the Screen menu.

No sound, picture okay

- Maybe sound is muted. Try pressing volume up button to restore sound.

No picture, no sound, but power is on

- Maybe cable/air function is in wrong position. Try another channel.
- Maybe a vacant channel is tuned. Try another channel.

Sound okay, picture poor

- Check antenna connections.
- Try adjusting sharpness function to improve weak signals.

ACCESSORIES

Remote Control

This is the remote that came packed with your TV. You can use the order form to order it direct by mail if desired.

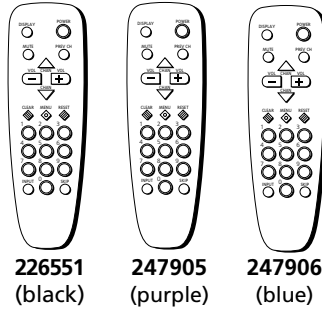

226551
(black)

247905
(purple)

247906
(blue)

Optional Remote

This remote not only controls your TV but can also control most brands of remote-controllable VCR's, cable boxes, and audio equipment.

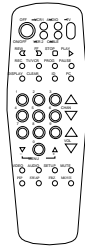

RCU500

Dipole Antenna

Designed to attach to the back of your TV. Can be used for both VHF and UHF channels.

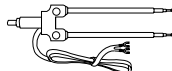

156265

Antenna Cables

Screw-on Antenna Cable

Attaches to the round antenna connectors (called 75-ohm F-type) on the back of your VCR or TV. The ends screw onto the connectors for a secure connection.

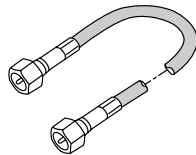

VH81 (3-ft)

Push-on Antenna Cable

Attaches to the round antenna connectors (called 75-ohm F-type) on the back of your VCR or TV. Ends push on for a quick connection.

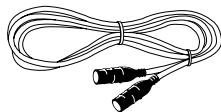

Gold-Tipped Cables
VH89 (6-ft), VH90(10-ft)

Note: All specifications and descriptions of accessories are subject to change without notice.

Accessory Order Form

Description	Stock No.	Price	Qty	Total
Transformer	VH54	\$ 2.95		
Cleaner/Polisher	AH035	\$ 6.95		
Screw-on Antenna Cable (3-ft)	VH81	\$ 3.95		
A/B Switch	AH041	\$14.95		
Gold-Tipped Antenna Cable (6-ft)	VH89	\$ 5.95		
Gold-Tipped Antenna Cable (10-ft)	VH90	\$ 7.95		
Optional Remote Control	RCU500	\$19.95		
Dipole Antenna	156265	\$11.15		
Antenna Adapter	193983	\$ 9.90		
Antenna Mixer	193984	\$11.15		
Replacement Remote Control (CRK10A1)	226551	\$18.60		
Replacement Remote Control (CRK10H1)	247905	\$24.95		
Replacement Remote Control (CRK10J1)	247906	\$24.95		

Prices are subject to change without notice.

Total Merchandise \$ _____

Sales Tax \$ _____

We are required by law to collect the appropriate sales tax for each individual state, county, and locality to which the merchandise is being sent.

Shipping, Handling \$ 5.00

Total Amount Enclosed \$ _____

Use VISA, MasterCard or Discover Card preferably.
Money order or check must be in U.S. currency only.
No COD or CASH.

All accessories are subject to availability.
Where applicable, we will ship a superseding model.

✂ Detach Here

Please Complete Other Side Also

ACCESSORIES

Charge your order on your VISA, MasterCard, or Discover Card by filling in below

USE YOUR CREDIT CARD

IMPORTANT: Copy complete account number from your VISA card



My card expires:

IMPORTANT: Copy complete account number from your MasterCard



Copy Number above your name on MasterCard:
 My card expires:

IMPORTANT: Copy complete account number from your Discover Card



My card expires:

AUTHORIZED SIGNATURE
 (Credit card order will not be processed without signature)

Print or type your name and address clearly.



A complete and correct order will save you days of waiting.

Name: _____
 Street: _____
 _____ Apt: _____
 City: _____
 State: _____ Zip: _____
 Phone Number: _____

Please make sure that both sides of this form have been filled out completely.

- Allow 4 weeks for delivery.
- All accessories are subject to availability.
- Prices are subject to change

Placing An Order

To place your order by phone, have your Visa, MasterCard or Discover Card ready and call the toll-free number listed below. Use this number only to place an order for accessory items listed on this order form.

1-800-338-0376

To place your order by mail, detach and mail the completed order form with credit card information, money order or check in US currency (made payable to Thomson Consumer Electronics, Inc.) to the following address:

Video Accessories
PO Box 8419
Ronks, PA 17573

Detach Here 

LIMITED WARRANTY

What your warranty covers:

- Any defect in materials or workmanship.

For how long after your purchase:

- 90 days for labor charges.
- One year for parts.
- Two years for the picture tube.

The warranty period for rental units begins with the first rental or 45 days from date of shipment to the rental firm, whichever comes first.

What we will do:

- Pay any Authorized RCA Television Service Center the labor charges to repair your television.
- Pay any Authorized RCA Television Service Center for the new or, at our option, refurbished replacement parts and picture tube required to repair your television.

How you get service:

- For screen sizes of 26" and smaller: Take your RCA television to any Authorized RCA Television Service Center and pick up when repairs are complete.
- For screen sizes larger than 26": Request home service from any Authorized RCA Television Service Center, provided that your television is located within the geographic territory covered by an Authorized RCA Television Service Center. If not, you must take your television to the Service Center location at your own expense, or pay for the cost the Service Center may charge to transport your television to and from your home.
- To identify your nearest Authorized RCA Television Service Center, ask your dealer, look in the Yellow Pages, or call 1-800-336-1900.
- Show the Authorized Service Center Representative your sales receipt or other evidence of purchase date or first rental.

What your warranty does not cover:

- Customer instruction. (Your Owner's Manual clearly describes how to install, adjust, and operate your television. Any additional information should be obtained from your dealer.)
- Installation and related adjustments.
- Signal reception problems not caused by your television.
- Damage from misuse or neglect.
- Batteries.
- Customer replacement fuses.
- Images burnt onto the screen.
- A television that has been modified or incorporated into other products or is used for institutional or other commercial purposes.
- A television purchased or serviced outside the U.S.A.
- Acts of God, such as but not limited to lightning damage.

Product Registration:

- Please complete and mail the Product Registration Card packed with your TV. It will make it easier to contact you should it ever be necessary. The return of the card is not required for warranty coverage.

How state law relates to this warranty:

- This warranty gives you specific legal rights, and you also may have other rights that vary from state to state.

If you purchased your product outside the United States:

- This warranty does not apply. Contact your dealer for warranty information.

Service calls which do not involve defective materials or workmanship are not covered by this warranty. Costs of such service calls are the sole responsibility of the purchaser.

Please do not send any products to the Indianapolis address listed in this manual or on the carton. This will only add delays in service for your product.

 **THOMSON CONSUMER ELECTRONICS**

**10330 North Meridian Street
Indianapolis, IN 46290**

©2000 Thomson Consumer Electronics, Inc.

Trademark(s)® Registered

Marca(s) Registrada(s)

Printed in USA

TOCOM 1558177A